



## THE ROUSSEAU DRAWER : FIRST TO THE FINISH LINE

### *The sturdiest and the most durable on the market*

Tested in an independent laboratory, the Rousseau drawer proved its superiority on many levels : loaded to its full capacity, the Rousseau drawer completed three times more cycles than the four major competing brands used in the same test, and all of this, without showing any signs of wear. The Rousseau drawer has become the champion of its category. Its durability is three times greater than that of the competition.

As a result, its performance can be defined in terms of its durability. The Rousseau drawer's sturdy construction offers superior output while having a much longer lifespan. This is why Rousseau doesn't even hesitate to offer a Lifetime Warranty on its modular drawer. An undeniable advantage!

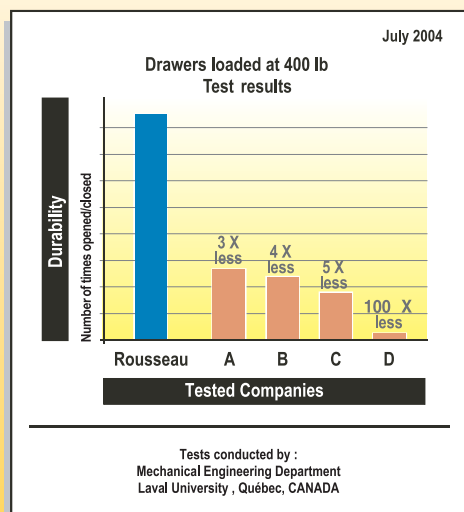

The Rousseau drawers last 3 times longer than their closest competitor's drawers.

### *A multitude of accessories*

The Rousseau drawer makes your work easy : The vast array of accessories offered, all of which are compatible with each other, contribute to maximizing the organization of your work space. In addition, all of these accessories can be easily rearranged according to your needs, making them a joy to use and displaying just how highly functional they are.

### *Streamlined design*

In addition to being sturdy and functional, the Rousseau drawer has an alluring appearance. It fits just as well in an office as it does in a factory. It allows you to arrange your work space in a harmonious and aesthetic fashion.

# Modular Drawer

## The Rousseau Advantages

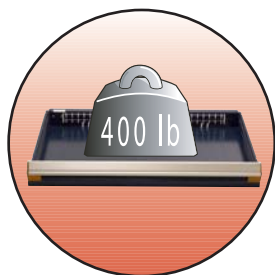

With a capacity of 400 lb, the drawer can be opened thousands of times without showing signs of slowing down.



10 drawer heights and 7 side heights are available.

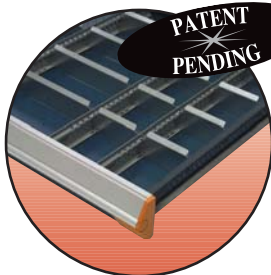

Partitions and dividers are clipped in.

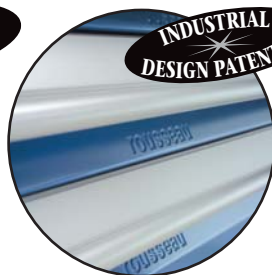

Company name embossed on the face of the drawer. If you don't see ROUSSEAU, it's not a ROUSSEAU.

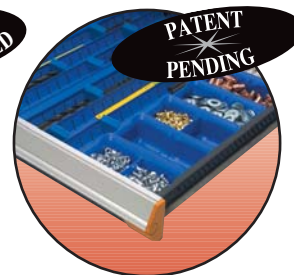

All accessories are compatible with each other.

## Details that make the difference

### ERGONOMIC

The full-width handle as well as the accessories (Integrated Lock-In mechanism, Lock-Out mechanism, lock, etc.) have been designed down to the smallest detail in order to make your work easier.

### EFFICIENT

A multitude of available accessories, such as partitions and dividers, plastic bins, groove trays, foam for tools and hanging file bars allow you to organize your space.

### ACCESSIBLE

Drawers open 100%, giving you complete access to the contents.



R5AEE-5825

### STURDY

400 lb capacity per drawer.



### DURABLE

Lifespan is 3 times longer than the closest competitor.

(Tests performed by an independent laboratory).



R5SEE-874803

### INGENIOUS

Accessories can be added at all times.

| Index                 | Page(s)   |
|-----------------------|-----------|
| <b>Modular Drawer</b> | 120 - 124 |
| Proposals             | 125 - 136 |
| Accessories           | 137 - 141 |

## 16 drawer sizes x 10 heights = 160 possible dimensions

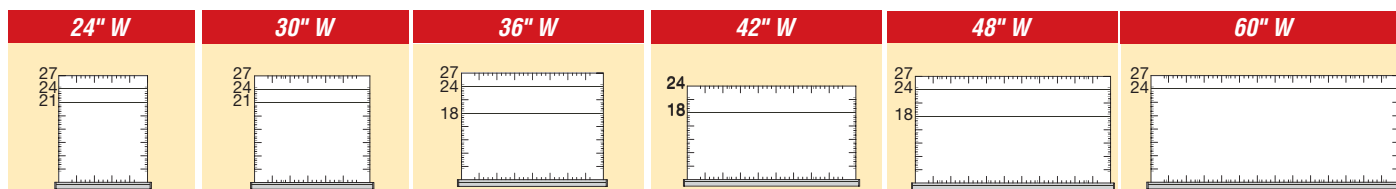

## Modular Drawers and Roll-Out Shelves

### Heavy-Duty Modular Drawer

RF31 / RF32



Drawer for cabinets (and multi-drawer) : RF31;  
 Drawers for shelving : RF32;  
 400 lb capacity, 100% extension;  
 Heavy-duty construction;  
 Easy to install;  
 Vast choice of accessories offered to adapt to your storage needs;  
 Available drawer heights :  
 3", 4", 5", 6", 7", 8", 9", 10", 12" and 14";

SEE PAGES 137-141

Order by specifying the type of application (cabinet or shelving) and adding the drawer height to the part #. Ex. : RF31-362406;

For modular drawers with layouts,

SEE PAGES 125-136

| Product # | W x D     |
|-----------|-----------|
| RF -2421  | 24" x 21" |
| RF -2427  | 24" x 27" |
| RF -3021  | 30" x 21" |
| RF -3027  | 30" x 27" |
| RF -3618  | 36" x 18" |
| RF -3624  | 36" x 24" |
| RF -4824  | 48" x 24" |
| RF -4827  | 48" x 27" |
| RF -6024  | 60" x 24" |
| RF -6027  | 60" x 27" |

### Heavy-Duty Front Access Roll-Out Shelf

RF40 / RF41



Roll-out shelf for cabinet (and multi-drawer) : RF40;  
 Roll-out shelf for shelving : RF41;  
 400 lb capacity, 100% extension;  
 Heavy-duty construction;  
 Easy to install;  
 Painted steel with 3" edges on sides and back;  
 Full access to contents;  
 Height : 6";

Order by specifying the type of application (cabinet or shelving). Ex. : RF40-3624.

| Product # | W x D     |
|-----------|-----------|
| RF -2421  | 24" x 21" |
| RF -2427  | 24" x 27" |
| RF -3021  | 30" x 21" |
| RF -3027  | 30" x 27" |
| RF -3618  | 36" x 18" |
| RF -3624  | 36" x 24" |
| RF -4824  | 48" x 24" |
| RF -4827  | 48" x 27" |
| RF -6024  | 60" x 24" |
| RF -6027  | 60" x 27" |

### Heavy-Duty 3-Sided Access Roll-Out Shelf

RF44 / RF45



Roll-out shelf, 3-sided access for cabinet (and multi-drawer) : RF44;  
 Roll-out shelf, 3-sided access for shelving : RF45;  
 400 lb capacity, 100% extension;  
 Heavy-duty construction;  
 Easy to install;  
 Galvanized steel with 1 1/2" edge on back;  
 Height : 5";  
 May serve as work surface;  
 Order by specifying the type of application (cabinet or shelving). Ex. : RF44-3624.

| Product # | W x D     |
|-----------|-----------|
| RF -2421  | 24" x 21" |
| RF -2427  | 24" x 27" |
| RF -3021  | 30" x 21" |
| RF -3027  | 30" x 27" |
| RF -3618  | 36" x 18" |
| RF -3624  | 36" x 24" |
| RF -4824  | 48" x 24" |
| RF -4827  | 48" x 27" |
| RF -6024  | 60" x 24" |
| RF -6027  | 60" x 27" |

## Drawer and Roll-Out Shelf Dimensions

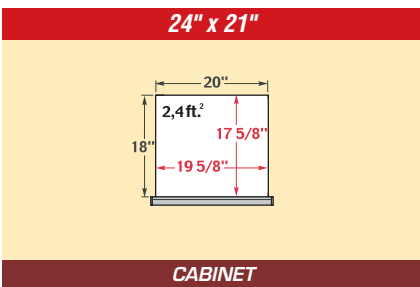
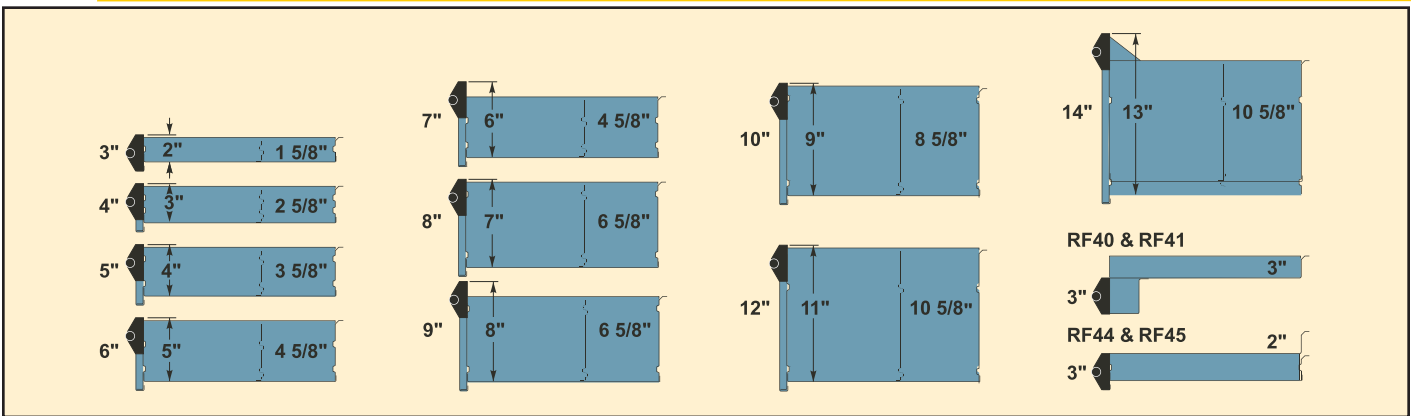

CABINET

RF31-2421  
 RF40-2421  
 RF44-2421

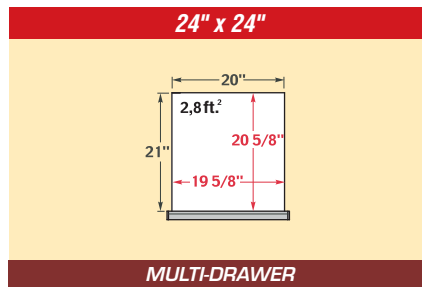

MULTI-DRAWER

SEE PAGES 42-47

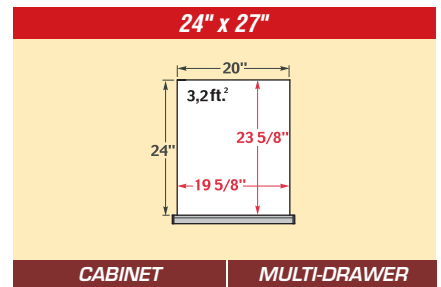

CABINET

MULTI-DRAWER

RF31-2427  
 RF40-2427  
 RF44-2427

SEE PAGES 42-47

# Modular Drawer

**30" x 21"**

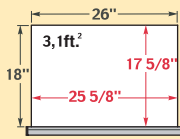

**CABINET**

RF31-3021  
RF40-3021  
RF44-3021

**30" x 24"**

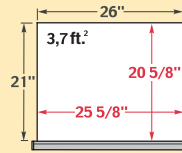

**SHELVING**

**MULTI-DRAWER**

RF32-3024  
RF41-3024  
RF45-3024

SEE PAGES 42-47

**30" x 27"**

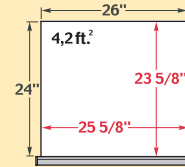

**CABINET**

**MULTI-DRAWER**

RF31-3027  
RF40-3027  
RF44-3027

SEE PAGES 42-47

**36" x 18"**

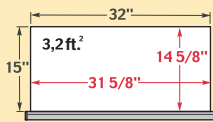

**CABINET**

**SHELVING**

RF31-3618  
RF40-3618  
RF44-3618

RF32-3618  
RF41-3618  
RF45-3618

**36" x 24"**

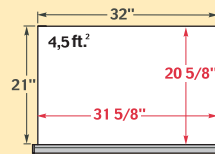

**CABINET**

**SHELVING**

**MULTI-DRAWER**

RF31-3624  
RF40-3624  
RF44-3624

RF32-3624  
RF41-3624  
RF45-3624

SEE PAGES 42-47

**36" x 27"**

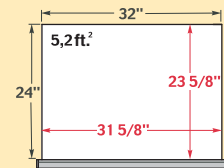

**MULTI-DRAWER**

SEE PAGES 42-47

**42" x 18"**

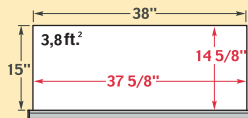

**SHELVING**

RF32-4218  
RF41-4218  
RF45-4218

**42" x 24"**

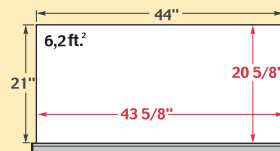

**SHELVING**

RF32-4224  
RF41-4224  
RF45-4224



R5ADG-5822

**MODULAR DRAWER**

**48" x 18"**

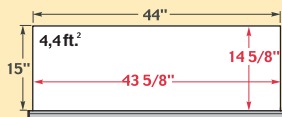

**SHELVING**

RF32-4818  
RF41-4818  
RF45-4818

**48" x 24"**

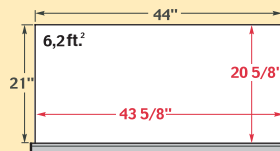

**CABINET**

**SHELVING**

**MULTI-DRAWER**

RF31-4824  
RF40-4824  
RF44-4824

RF32-4824  
RF41-4824  
RF45-4824

SEE PAGES 42-47

**48" x 27"**

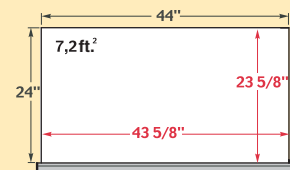

**CABINET**

**MULTI-DRAWER**

RF31-4827  
RF40-4827  
RF44-4827

SEE PAGES 42-47

**60" x 24"**

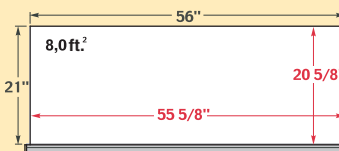

**CABINET**

**MULTI-DRAWER**

RF31-6024  
RF40-6024  
RF44-6024

SEE PAGES 42-47

**60" x 27"**

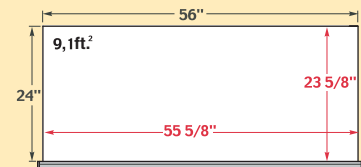

**CABINET**

**MULTI-DRAWER**

RF31-6027  
RF40-6027  
RF44-6027

SEE PAGES 42-47



R5EKG-5808

## How to Order a Drawer

You can choose a drawer model from among our proposals with layouts :

**00** for layout kit only

**51** for a drawer in a cabinet, with layout

**52** for a drawer in shelving, with layout,

SEE PAGES 125-136

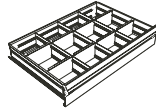

EXAMPLE: R EE-A0200

Height of drawer

SEE PAGE 122

Locking or security mechanism

SEE PAGE 141

Example : R52EE-A020006 L3A for a drawer (36" W x 24" D) in shelving, with layout, 6" drawer height with lock on drawer and integrated Lock-in mechanism.

You can create a personalized model by choosing an empty drawer (to which you can add layout accessories) :

**31** for a drawer in a cabinet

**32** for a drawer in shelving

EXAMPLE: RF - 3624

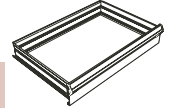

Height of drawer

SEE PAGE 122

Locking or security mechanism

SEE PAGE 141

To add layout accessories, accessories must be ordered separately

SEE PAGES 137-141

Example : RF31-362406 L3A for a drawer (36" W x 24" D) for cabinet, 6" drawer height with lock on the drawer and integrated Lock-in mechanism.

To calculate drawer compartment dimensions, refer to the following illustration.

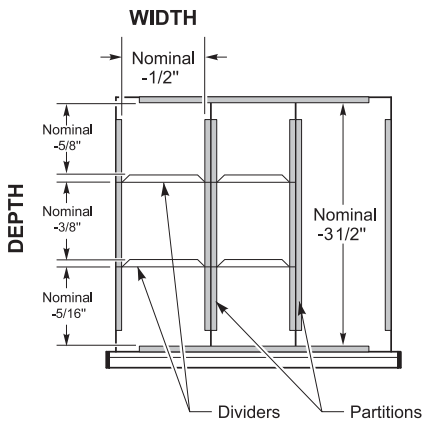

### Drawer dimensions

| INSIDE DEPTH | INSIDE WIDTH |         |         |         |         |         |
|--------------|--------------|---------|---------|---------|---------|---------|
|              | 20"          | 26"     | 32"     | 38"     | 44"     | 56"     |
| 24"          | 24"x27"      | 30"x27" | 36"x27" | 48"x27" | 60"x27" |         |
| 21"          |              |         |         |         |         |         |
| 18"          | 24"x24"      | 30"x24" | 36"x24" | 42"x24" | 48"x24" | 60"x24" |
| 15"          | 24"x21"      | 30"x21" |         |         |         |         |
|              |              |         | 36"x18" | 42"x18" | 48"x18" |         |

## How to Order a Roll-Out Shelf

Complete the first portion of the # according to the type of roll-out shelf being ordered :

**40** for a roll-out shelf in a cabinet

**41** for a roll-out shelf in shelving

**44** for roll-out shelf with 3-sided access for cabinet

**45** for roll-out shelf with 3-sided access for shelving

EXAMPLE: RF - 3624

Locking or security mechanism

SEE PAGE 141

Complete Example : RF41-3624A for a roll-out shelf with 3-sided access for a cabinet, with integrated Lock-In mechanism.



R5XEE-2002

# Proposals

To order, complete the part number with the drawer height :

**00** for compartments only

**51** for a drawer in a cabinet, with layout

**52** for a drawer in shelving, with layout

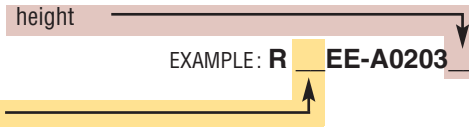

Complete Example : R51CD-A010206  
for a drawer with compartments for a  
24" W x 21" D cabinet, 6" high.

## 24" x 21" (W x D) Drawers

For Cabinet

### Partitions and Dividers

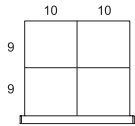

R\_CD-A0102  
4 compartments

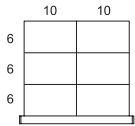

R\_CD-A0104  
6 compartments

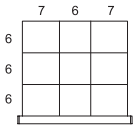

R\_CD-A0206  
9 compartments

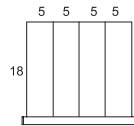

R\_CD-A0300  
4 compartments

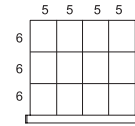

R\_CD-A0308  
12 compartments

### Plastic Bins

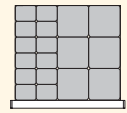

R\_CD-E018  
18 bins

### Groove Trays

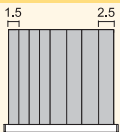

R\_CD-G00803  
8 groove trays

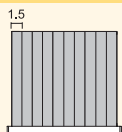

R\_CD-G01003  
10 groove trays

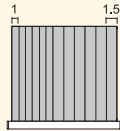

R\_CD-G01203  
12 groove trays

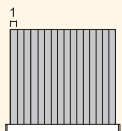

R\_CD-G01603  
16 groove trays  
2 dividers included with each groove tray.

### Foam

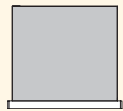

R\_CD-J0103  
For protection

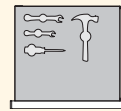

R\_CD-J0203  
For tools

Cut-outs in the foam  
are not provided by  
Rousseau. They must  
be made by the user.

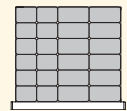

R\_CD-E024  
24 bins

### Folder Hanging Bars

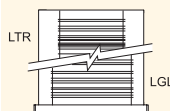

R\_CD-KFB12



R\_CD-KLR12

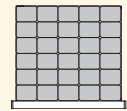
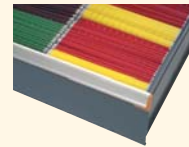

R\_CD-E030  
30 bins

## 24" x 24" (W x D) Drawers

For multi-drawer\*

\* These proposals include compartments only.

### Partitions and Dividers

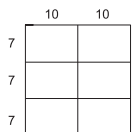

R00CE-A0104  
6 compartments

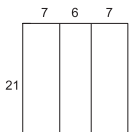

R00CE-A0200  
3 compartments

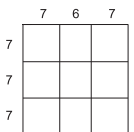

R00CE-A0206  
9 compartments

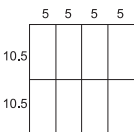

R00CE-A0304  
8 compartments

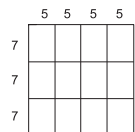

R00CE-A0308  
12 compartments

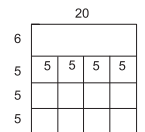

R00CE-C0408  
13 compartments

### Plastic Bins

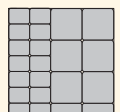

R00CE-E022  
22 bins

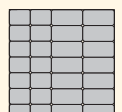

R00CE-E028  
28 bins

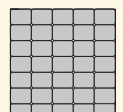

R00CE-E035  
35 bins

### Groove Trays

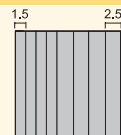

R00CE-G00803  
8 groove trays

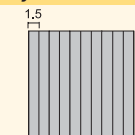

R00CE-G01003  
10 groove trays

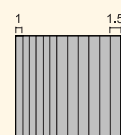

R00CE-G01203  
12 groove trays

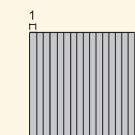

R00CE-G01603  
16 groove trays  
2 dividers included with each groove tray.

### Folder Hanging Bars

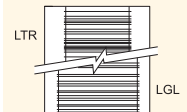

R00CE-KFB12



R00CE-KLR12

### Foam



R00CE-J0103  
For protection

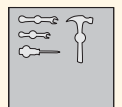

R00CE-J0203  
For tools

Cut-outs in the foam  
are not provided by  
Rousseau. They must  
be made by the user.

## 24" x 27" (W x D) Drawers

For Cabinet

For Multi-Drawer

### Partitions and Dividers

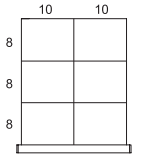

**R\_CG-A0104**  
6 compartments

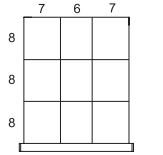

**R\_CG-A0206**  
9 compartments

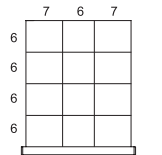

**R\_CG-A0209**  
12 compartments

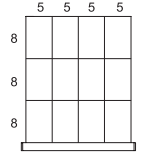

**R\_CG-A0308**  
12 compartments

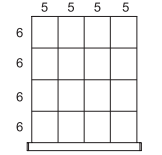

**R\_CG-A0312**  
16 compartments

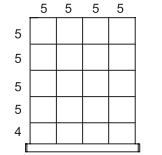

**R\_CG-A0316**  
20 compartments

### Plastic Bins

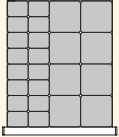

**R\_CG-E024**  
24 bins

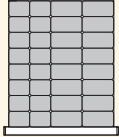

**R\_CG-E032**  
32 bins

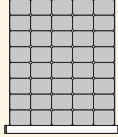

**R\_CG-E040**  
40 bins

### Foam

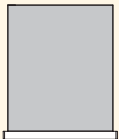

**R\_CG-J0103**  
For protection

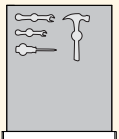

**R\_CG-J0203**  
For tools



*Cut-outs in the foam are not provided by Rousseau. They must be made by the user.*

### Groove Trays

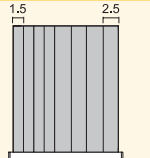

**R\_CG-G00803**  
8 groove trays

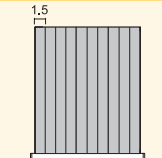

**R\_CG-G01003**  
10 groove trays

*2 dividers included with each groove tray.*

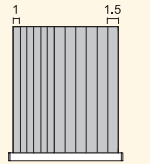

**R\_CG-G01203**  
12 groove trays

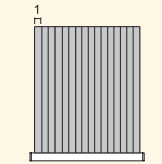

**R\_CG-G01603**  
16 groove trays

### Folder Hanging Bars

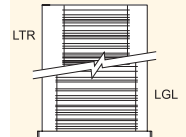

**R\_CG-KFB12**

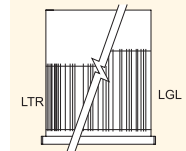

**R\_CG-KLR12**

## 30" x 21" (W x D) Drawers

For Cabinet

### Partitions and Dividers

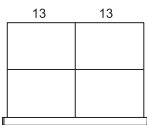

**R\_DD-A0102**  
4 compartments

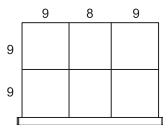

**R\_DD-A0203**  
6 compartments

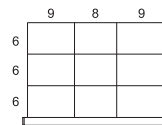

**R\_DD-A0206**  
9 compartments

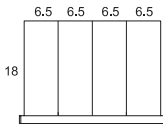

**R\_DD-A0300**  
4 compartments

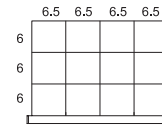

**R\_DD-A0308**  
12 compartments

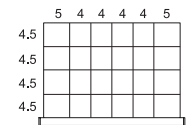

**R\_DD-A0518**  
24 compartments

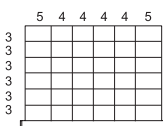

**R\_DD-A0530**  
36 compartments

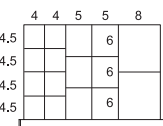

**R\_DD-D0411**  
16 compartments

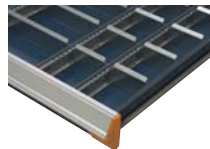

### Groove Trays

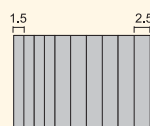

**R\_DD-G01003**  
10 groove trays

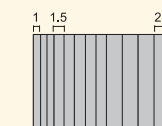

**R\_DD-G01203**  
12 groove trays

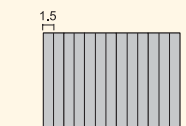

**R\_DD-G01303**  
13 groove trays

### Plastic Bins

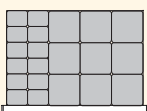

**R\_DD-E021**  
21 bins

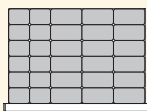

**R\_DD-E030**  
30 bins

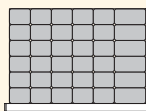

**R\_DD-E036**  
36 bins

### Foam

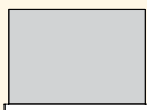

**R\_DD-J0103**  
For protection

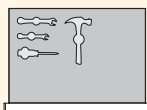

**R\_DD-J0203**  
For tools



*Cut-outs in the foam are not provided by Rousseau. They must be made by the user.*

### Folder Hanging Bars

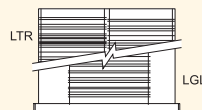

**R\_DD-KFB12**



**R\_DD-KLR12**

*2 dividers included with each groove tray.*

MODULAR DRAWER

# Proposals

## 30" x 24" (W x D) Drawers

For Shelving

For Multi-Drawer

### Partitions and Dividers

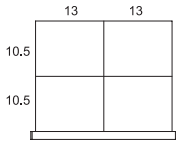

**R\_DE-A0102**  
4 compartments

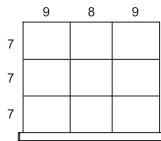

**R\_DE-A0206**  
9 compartments

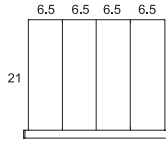

**R\_DE-A0300**  
4 compartments

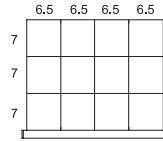

**R\_DE-A0308**  
12 compartments

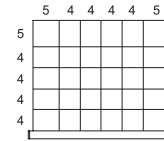

**R\_DE-A0524**  
30 compartments

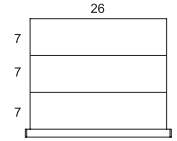

**R\_DE-B0200**  
3 compartments

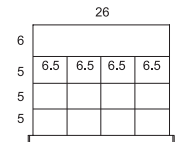

**R\_DE-C0408**  
13 compartments

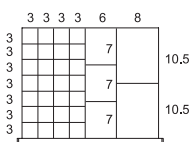

**R\_DE-D0527**  
33 compartments

### Groove Trays

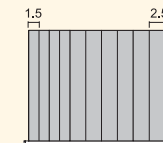

**R\_DE-G01003**  
10 groove trays

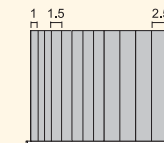

**R\_DE-G01203**  
12 groove trays

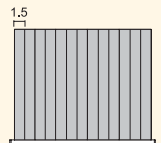

**R\_DE-G01303**  
13 groove trays

2 dividers included with each groove tray.

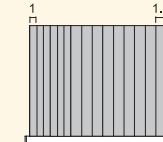

**R\_DE-G01503**  
15 groove trays

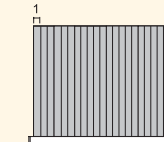

**R\_DE-G02103**  
21 groove trays

### Plastic Bins

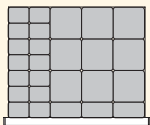

**R\_DE-E026**  
26 bins

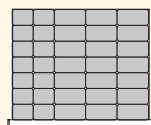

**R\_DE-E035**  
35 bins

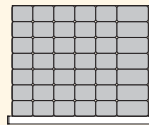

**R\_DE-E042**  
42 bins

### Foam



**R\_DE-J0103**  
For protection

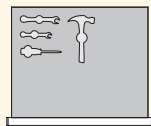

**R\_DE-J0203**  
For tools

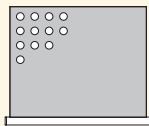

**R\_DE-J0303**  
For collets



*Cut-outs in the foam are not provided by Rousseau. They must be made by the user.*

### Folder Hanging Bars

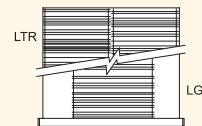

**R\_DE-KFB12**



**R\_DE-KLR12**

## 30" x 27" (W x D) Drawers

For Cabinet

For Multi-Drawer

### Partitions and Dividers

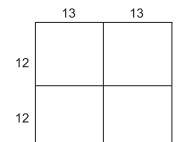

**R\_DG-A0102**  
4 compartments

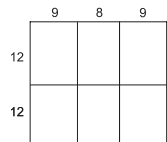

**R\_DG-A0203**  
6 compartments

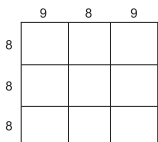

**R\_DG-A0206**  
9 compartments

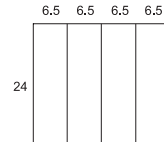

**R\_DG-A0300**  
4 compartments

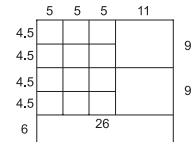

**R\_DG-C0410**  
15 compartments

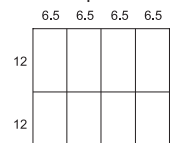

**R\_DG-A0304**  
8 compartments

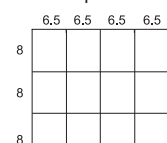

**R\_DG-A0308**  
12 compartments

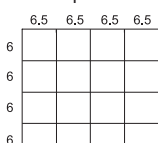

**R\_DG-A0312**  
16 compartments

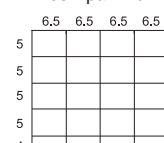

**R\_DG-A0316**  
20 compartments

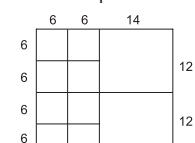

**R\_DG-D0207**  
10 compartments

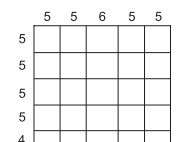

**R\_DG-A0420**  
25 compartments

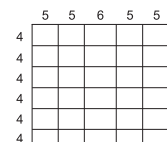

**R\_DG-A0425**  
30 compartments

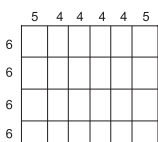

**R\_DG-A0518**  
24 compartments

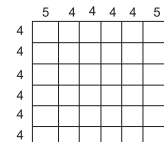

**R\_DG-A0530**  
36 compartments

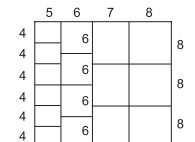

**R\_DG-D0312**  
16 compartments

### Plastic Bins (30" x 27" drawers continued)

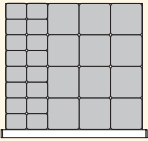

**R\_DG-E028**  
28 bins

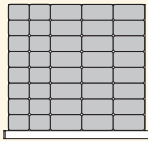

**R\_DG-E040**  
40 bins

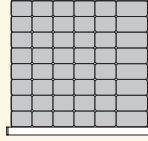

**R\_DG-E048**  
48 bins

### Foam

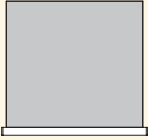

**R\_DG-J0103**  
For protection

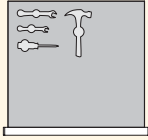

**R\_DG-J0203**  
For tools

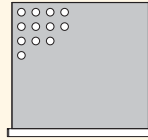

**R\_DG-J0303**  
For collets

### Folder Hanging Bars

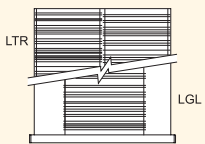

**R\_DG-KFB12**

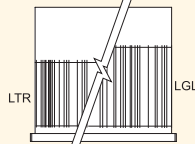

**R\_DG-KLR12**



*Cut-outs in the foam are not provided by Rousseau. They must be made by the user.*

### Groove Trays (30" x 27" drawers continued)

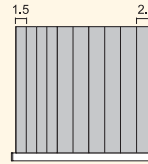

**R\_DG-G01003**  
10 groove trays

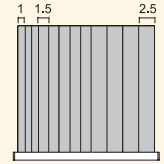

**R\_DG-G01203**  
12 groove trays

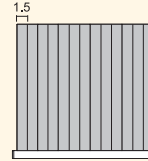

**R\_DG-G01303**  
13 groove trays

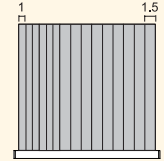

**R\_DG-G01503**  
15 groove trays

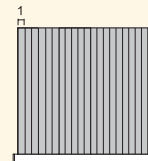

**R\_DG-G02103**  
21 groove trays

*2 dividers included with each groove tray.*

## 36" x 18" (W x D) Drawers

For Cabinet

For Shelving

### Partitions and Dividers

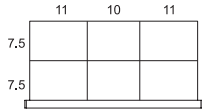

**R\_EC-A0203**  
6 compartments

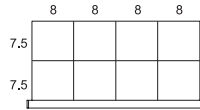

**R\_EC-A0304**  
8 compartments

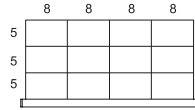

**R\_EC-A0308**  
12 compartments

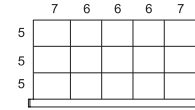

**R\_EC-A0410**  
15 compartments

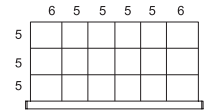

**R\_EC-A0512**  
18 compartments

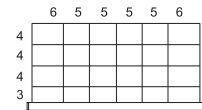

**R\_EC-A0518**  
24 compartments

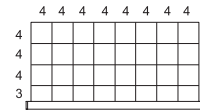

**R\_EC-A0724**  
32 compartments

### Plastic Bins

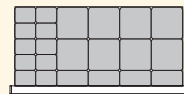

**R\_EC-E022**  
22 bins

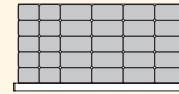

**R\_EC-E030**  
30 bins

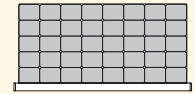

**R\_EC-E040**  
40 bins

### Groove Trays

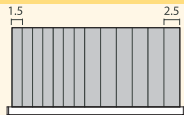

**R\_EC-G01303**  
13 groove trays

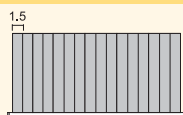

**R\_EC-G01603**  
16 groove trays

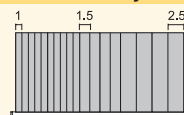

**R\_EC-G01803**  
18 groove trays

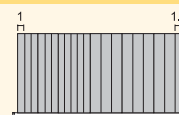

**R\_EC-G02003**  
20 groove trays

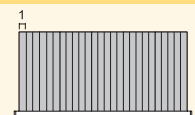

**R\_EC-G02603**  
26 groove trays

*2 dividers included with each groove tray.*

### Foam



**R\_EC-J0103**  
For protection

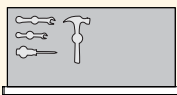

**R\_EC-J0203**  
For tools

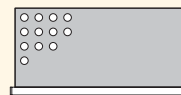

**R\_EC-J0303**  
For collets

### Folder Hanging Bars

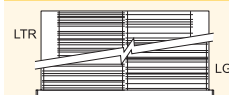

**R\_EC-KFB12**



**R\_EC-KLR12**



*Cut-outs in the foam are not provided by Rousseau. They must be made by the user.*

# Proposals

**36" x 24" (W x D) Drawers**

**For Cabinet**

**For Shelving**

**For Multi-Drawer**

## Partitions and Dividers

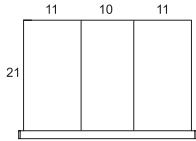

**R\_EE-A0200**  
3 compartments

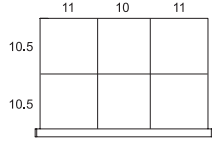

**R\_EE-A0203**  
6 compartments

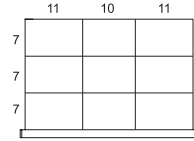

**R\_EE-A0206**  
9 compartments

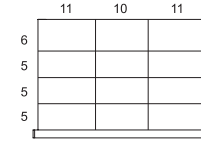

**R\_EE-A0209**  
12 compartments

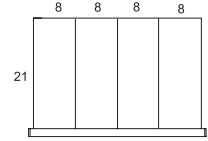

**R\_EE-A0300**  
4 compartments

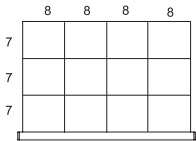

**R\_EE-A0308**  
12 compartments

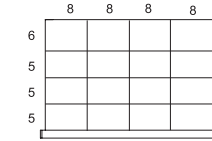

**R\_EE-A0312**  
16 compartments

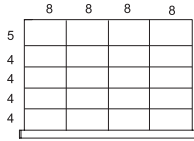

**R\_EE-A0316**  
20 compartments

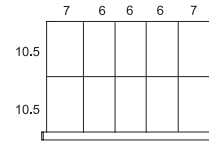

**R\_EE-A0405**  
10 compartments

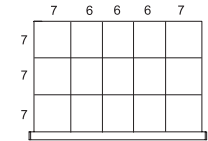

**R\_EE-A0410**  
15 compartments

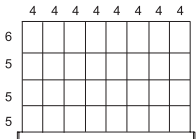

**R\_EE-A0724**  
32 compartments

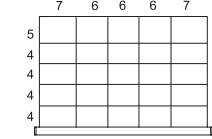

**R\_EE-A0420**  
25 compartments

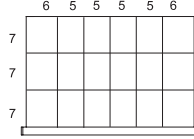

**R\_EE-A0512**  
18 compartments

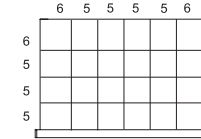

**R\_EE-A0518**  
24 compartments

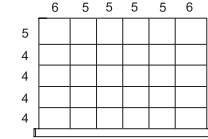

**R\_EE-A0524**  
30 compartments

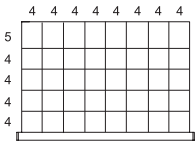

**R\_EE-A0732**  
40 compartments

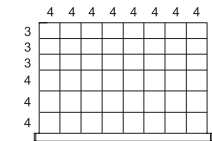

**R\_EE-A0740**  
48 compartments

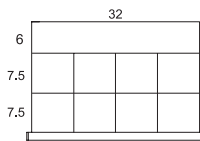

**R\_EE-C0404**  
9 compartments

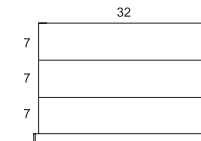

**R\_EE-B0200**  
3 compartments

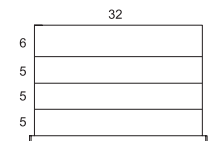

**R\_EE-B0300**  
4 compartments

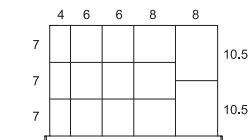

**R\_EE-D0409**  
14 compartments

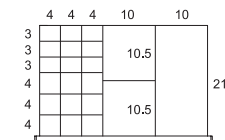

**R\_EE-D0416**  
21 compartments

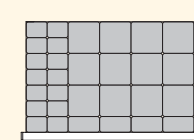

**R\_EE-E030**  
30 bins

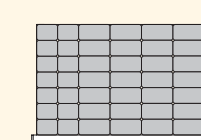

**R\_EE-E042**  
42 bins

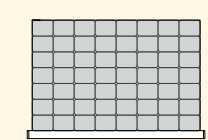

**R\_EE-E056**  
56 bins

## Plastic Bins

## Groove Trays

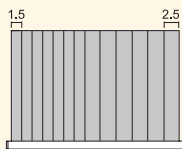

**R\_EE-G01303**  
13 groove trays

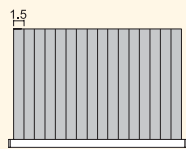

**R\_EE-G01603**  
16 groove trays

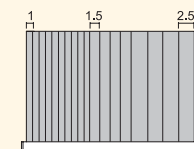

**R\_EE-G01803**  
18 groove trays

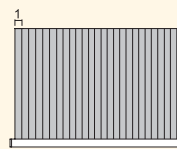

**R\_EE-G02603**  
26 groove trays

2 dividers included with each groove tray.

## Foam

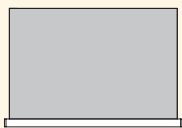

**R\_EE-J0103**  
For protection

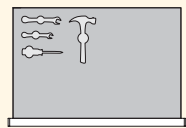

**R\_EE-J0203**  
For tools

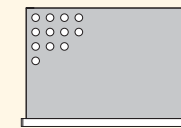

**R\_EE-J0303**  
For collets

## Folder Hanging Bars

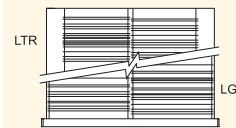

**R\_EE-KFB12**



**R\_EE-KLR12**



Cut-outs in the foam are not provided by Rousseau. They must be made by the user.

## 36" x 27" (W x D) Drawers

For Multi-Drawer\*

\* These proposals include compartments only.

### Partitions and Dividers

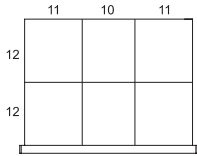

**R00EG-A0203**  
6 compartments

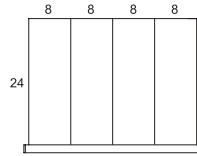

**R00EG-A0300**  
4 compartments

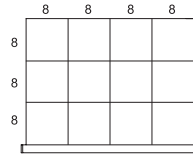

**R00EG-A0308**  
12 compartments

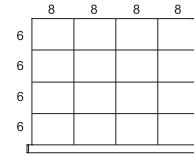

**R00EG-A0312**  
16 compartments

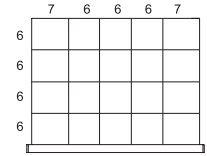

**R00EG-A0415**  
20 compartments

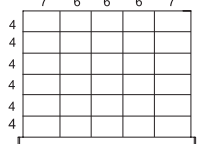

**R00EG-A0425**  
30 compartments

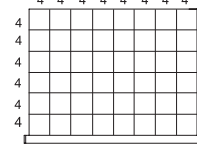

**R00EG-A0740**  
48 compartments

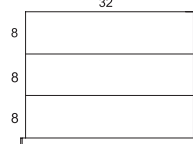

**R00EG-B0200**  
3 compartments

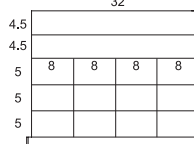

**R00EG-C0508**  
14 compartments

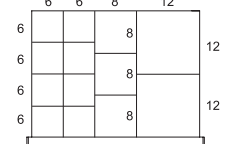

**R00EG-D0309**  
13 compartments

### Plastic Bins

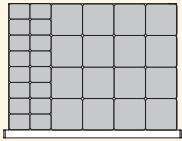

**R00EG-E032**  
32 bins

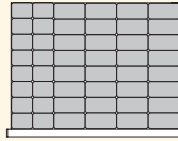

**R00EG-E048**  
48 bins

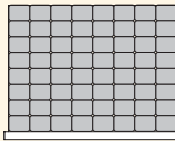

**R00EG-E064**  
64 bins

### Groove Trays

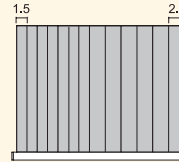

**R00EG-G01303**  
13 groove trays

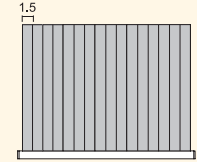

**R00EG-G01603**  
16 groove trays

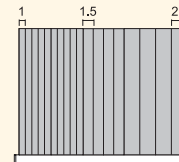

**R00EG-G01803**  
18 groove trays

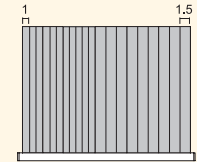

**R00EG-G02003**  
20 groove trays

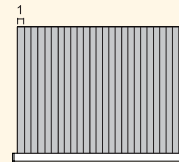

**R00EG-G02603**  
26 groove trays

2 dividers included with each groove tray.

### Foam



**R00EG-J0103**  
For protection

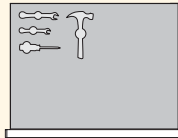

**R00EG-J0203**  
For tools

**Warning:** Cut-outs in the foam are not provided by Rousseau. They must be made by the user.

### Folder Hanging Bars

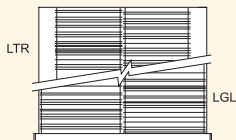

**R00EG-KFB12**

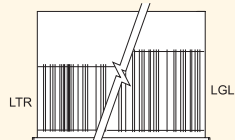

**R00EG-KLR12**

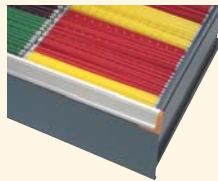

## 42" x 18" (W x D) Drawers

For Shelving

### Partitions and Dividers

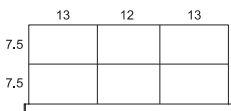

**R\_GC-A0203**  
6 compartments

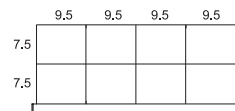

**R\_GC-A0304**  
8 compartments

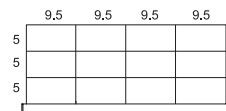

**R\_GC-A0308**  
12 compartments

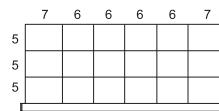

**R\_GC-A0512**  
18 compartments

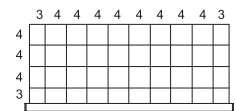

**R\_GC-A0930**  
40 compartments

# Proposals

## Plastic Bins (42" x 18" drawers continued)

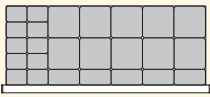

**R\_GC-E025**  
25 bins

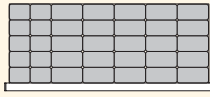

**R\_GC-E035**  
35 bins

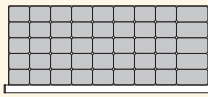

**R\_GC-E045**  
45 bins

## Foam



**R\_GC-J0103**  
For protection

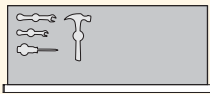

**R\_GC-J0203**  
For tools



*Cut-outs in the foam are not provided by Rousseau. They must be made by the user.*

## Folder Hanging Bars

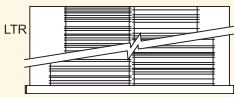

**R\_GC-KFB12**

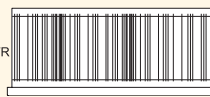

**R\_GC-KLR12**

## Groove Trays (42" x 18" drawers continued)

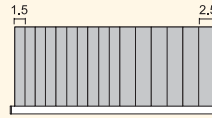

**R\_GC-G016**  
16 groove trays

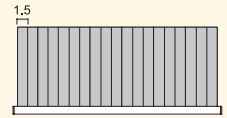

**R\_GC-G019**  
19 groove trays

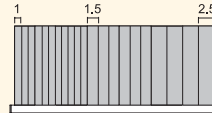

**R\_GC-G021**  
21 groove trays

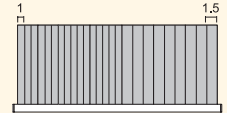

**R\_GC-G025**  
25 groove trays

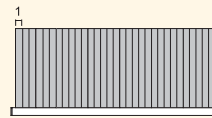

**R\_GC-G031**  
31 groove trays

*2 dividers included with each groove tray.*

## 42" x 24" (W x D) Drawers

**For Shelving**

## Partitions and Dividers

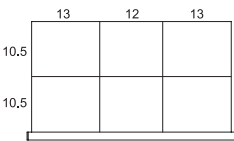

**R\_GE-A0203**  
6 compartments

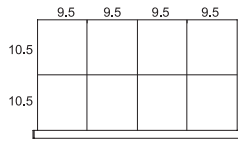

**R\_GE-A0304**  
8 compartments

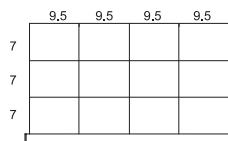

**R\_GE-A0308**  
12 compartments

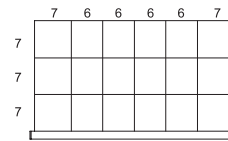

**R\_GE-A0512**  
18 compartments

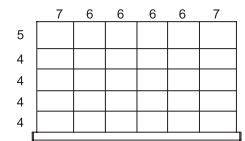

**R\_GE-A0524**  
30 compartments

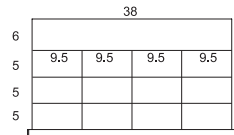

**R\_GE-C0408**  
13 compartments

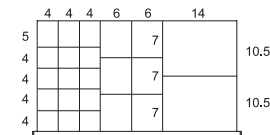

**R\_GE-D0517**  
23 compartments

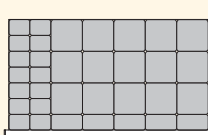

**R\_GE-E034**  
34 bins

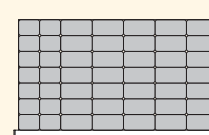

**R\_GE-E049**  
49 bins

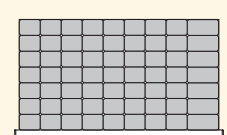

**R\_GE-E063**  
63 bins

## Plastic Bins

## Groove Trays

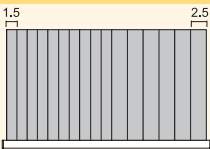

**R\_GE-G01603**  
16 groove trays

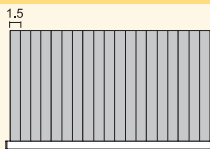

**R\_GE-G01903**  
19 groove trays

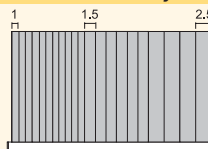

**R\_GE-G02103**  
21 groove trays

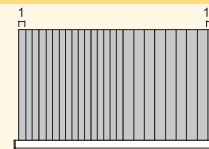

**R\_GE-G02503**  
25 groove trays

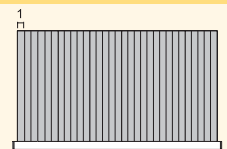

**R\_GE-G03103**  
31 groove trays

*2 dividers included with each groove tray.*

## Folder Hanging Bars

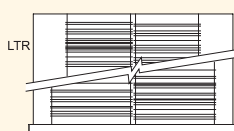

**R\_GE-KFB12**

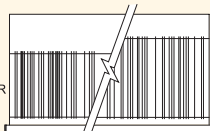

**R\_GE-KLR12**

## Foam

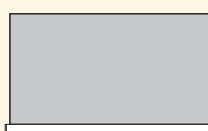

**R\_GE-J0103**  
For protection

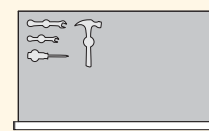

**R\_GE-J0203**  
For tools



*Cut-outs in the foam are not provided by Rousseau. They must be made by the user.*

MODULAR  
DRAWER

## 48" x 18" (W x D) Drawers

For Shelving

### Partitions and Dividers

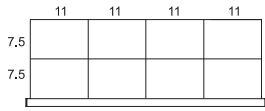

**R\_HC-A0304**  
8 compartments

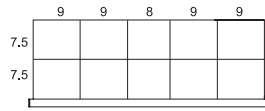

**R\_HC-A0405**  
10 compartments

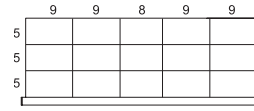

**R\_HC-A0410**  
15 compartments

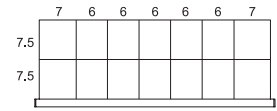

**R\_HC-A0607**  
14 compartments

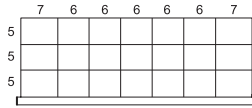

**R\_HC-A0614**  
21 compartments

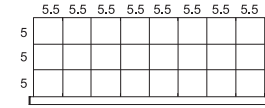

**R\_HC-A0716**  
24 compartments

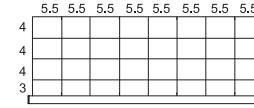

**R\_HC-A0724**  
32 compartments

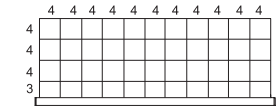

**R\_HC-A1033**  
44 compartments

### Plastic Bins

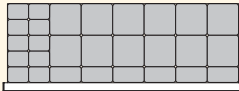

**R\_HC-E028**  
28 bins

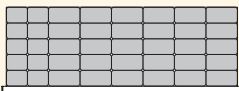

**R\_HC-E040**  
40 bins

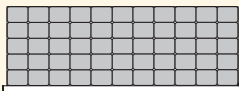

**R\_HC-E055**  
55 bins

### Foam



**R\_HC-J0103**  
For protection

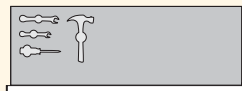

**R\_HC-J0203**  
For tools



*Cut-outs in the foam are not provided by Rousseau. They must be made by the user.*

### Groove Trays

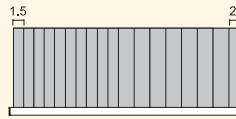

**R\_HC-G01803**  
18 groove trays

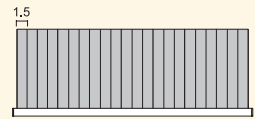

**R\_HC-G02203**  
22 groove trays

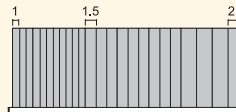

**R\_HC-G02403**  
24 groove trays

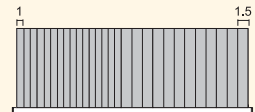

**R\_HC-G02803**  
28 groove trays

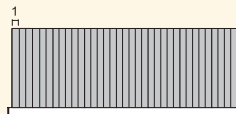

**R\_HC-G03603**  
36 groove trays

*2 dividers included per groove tray.*

### Folder Hanging Bars

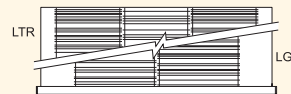

**R\_HC-KFB12**



**R\_HC-KLR12**



MODULAR DRAWER

# Proposals

48" x 24" (W x D)

For Cabinet

For Shelving

For Multi-Drawer

## Partitions and Dividers

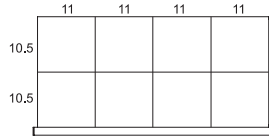

**R\_HE-A0304**  
8 compartments

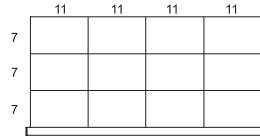

**R\_HE-A0308**  
12 compartments

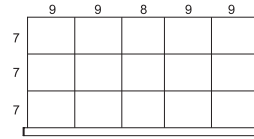

**R\_HE-A0410**  
15 compartments

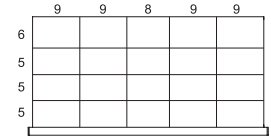

**R\_HE-A0415**  
20 compartments

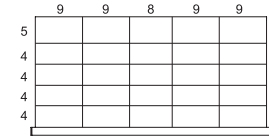

**R\_HE-A0420**  
25 compartments

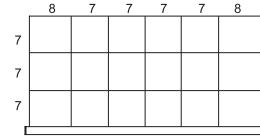

**R\_HE-A0512**  
18 compartments

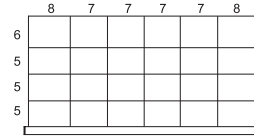

**R\_HE-A0518**  
24 compartments

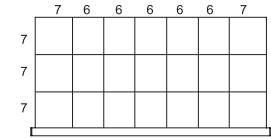

**R\_HE-A0614**  
21 compartments

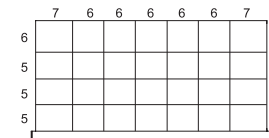

**R\_HE-A0621**  
28 compartments

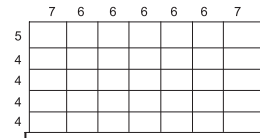

**R\_HE-A0628**  
35 compartments

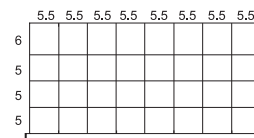

**R\_HE-A0724**  
32 compartments

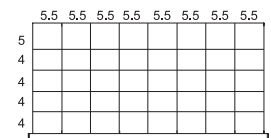

**R\_HE-A0732**  
40 compartments

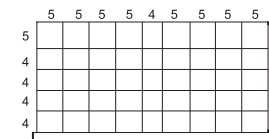

**R\_HE-A0836**  
45 compartments

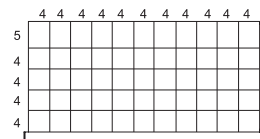

**R\_HE-A1044**  
55 compartments

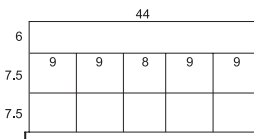

**R\_HE-C0505**  
11 compartments

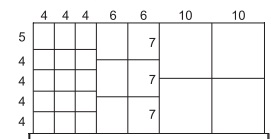

**R\_HE-D0618**  
25 compartments

## Plastic Bins

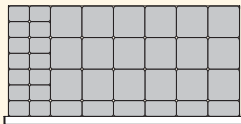

**R\_HE-E038**  
38 bins

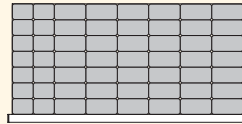

**R\_HE-E056**  
56 bins

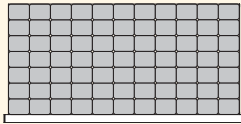

**R\_HE-E077**  
77 bins

## Groove Trays

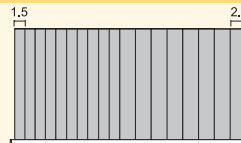

**R\_HE-G01803**  
18 groove trays

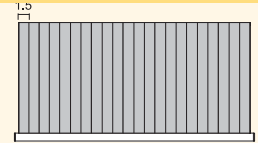

**R\_HE-G02203**  
22 groove trays

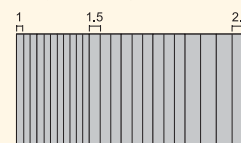

**R\_HE-G02403**  
24 groove trays

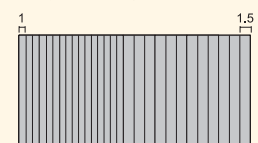

**R\_HE-G02803**  
28 groove trays

## Folder Hanging Bars

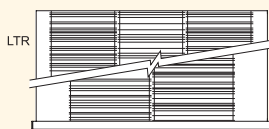

**R\_HE-KFB12**

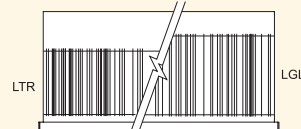

**R\_HE-KLR12**

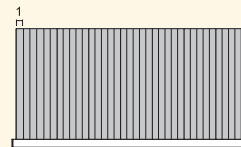

**R\_HE-G03603**  
36 groove trays

2 dividers included with each groove tray.

## Foam

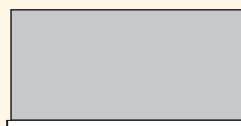

**R\_HE-J0103**  
For protection

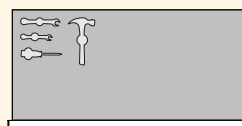

**R\_HE-J0203**  
For tools

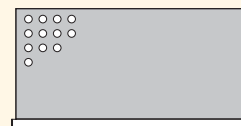

**R\_HE-J0303**  
For collets



Cut-outs in the foam are not provided by Rousseau. They must be made by the user.

MODULAR  
DRAWER

## 48" x 27" (W x D) Drawers

For Cabinet

For Multi-Drawer

### Partitions and Dividers

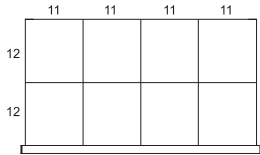

**R\_HG-A0304**  
8 compartments

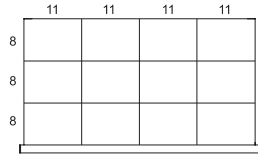

**R\_HG-A0308**  
12 compartments

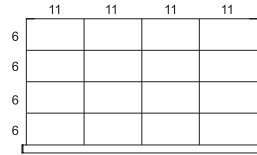

**R\_HG-A0312**  
16 compartments

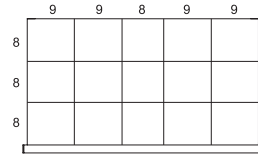

**R\_HG-A0410**  
15 compartments

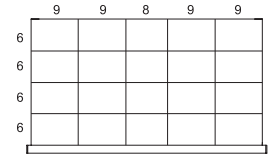

**R\_HG-A0415**  
20 compartments

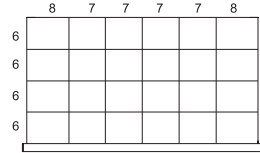

**R\_HG-A0518**  
24 compartments

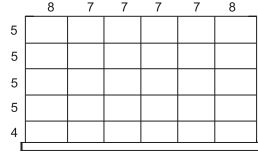

**R\_HG-A0524**  
30 compartments

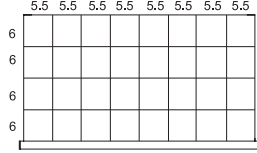

**R\_HG-A0724**  
32 compartments

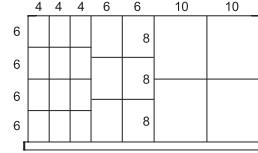

**R\_HG-D0615**  
22 compartments

### Plastic Bins

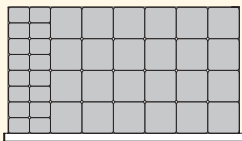

**R\_HG-E040**  
40 bins

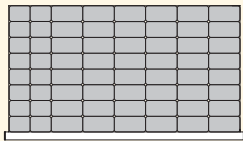

**R\_HG-E064**  
64 bins

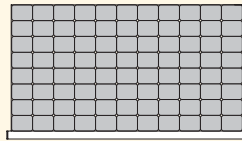

**R\_HG-E088**  
88 bins

### Groove Trays

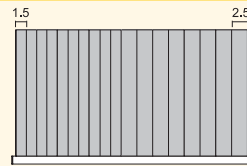

**R\_HG-G01803**  
18 groove trays

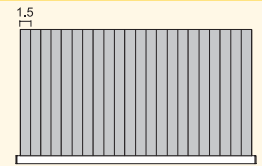

**R\_HG-G02203**  
22 groove trays

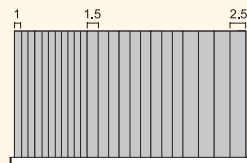

**R\_HG-G02403**  
24 groove trays

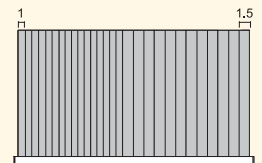

**R\_HG-G02803**  
28 groove trays

### Foam



**R\_HG-J0103**  
For protection

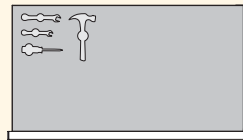

**R\_HG-J0203**  
For tools



*Cut-outs in the foam are not provided by Rousseau. They must be made by the user.*

### Folder Hanging Bars

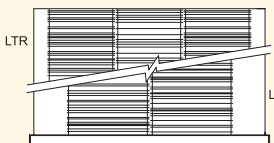

**R\_HG-KFB12**

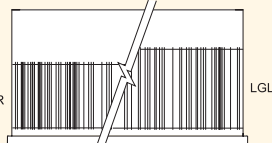

**R\_HG-KLR12**

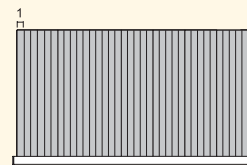

**R\_HG-G03603**  
36 groove trays

*2 dividers included with each groove tray.*



MODULAR DRAWER

# Proposals

## 60" x 24" (W x D) Drawers

For Cabinet

For Multi-Drawer

### Partitions and Dividers

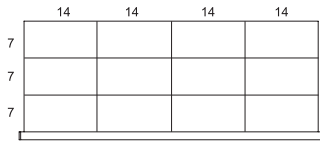

**R\_KE-A0308**  
12 compartments

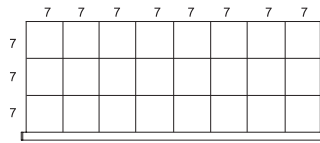

**R\_KE-A0716**  
24 compartments

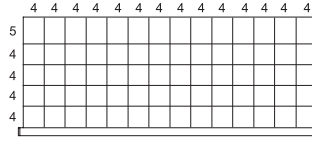

**R\_KE-A1356**  
70 compartments

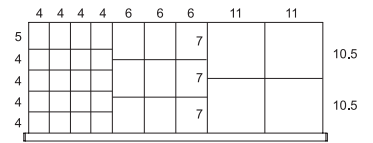

**R\_KE-D0824**  
33 compartments

### Plastic Bins

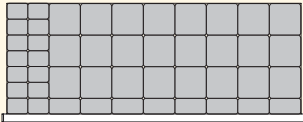

**R\_KE-E046**  
46 bins

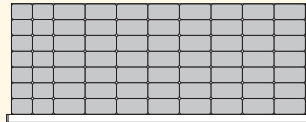

**R\_KE-E070**  
70 bins

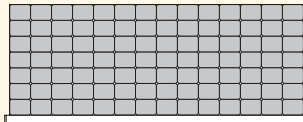

**R\_KE-E098**  
98 bins

### Groove Trays

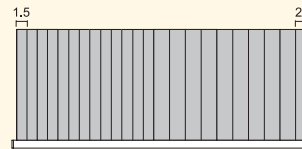

**R\_KE-G02303**  
23 groove trays

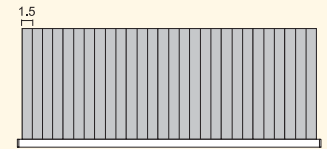

**R\_KE-G02803**  
28 groove trays

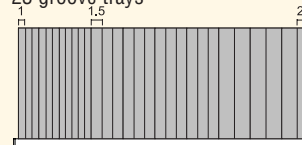

**R\_KE-G02903**  
29 groove trays

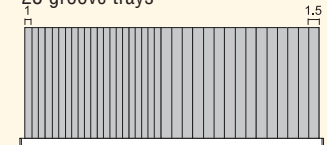

**R\_KE-G03603**  
36 groove trays

### Foam

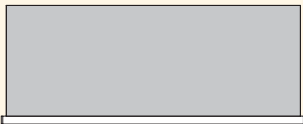

**R\_KE-J0103**  
For protection

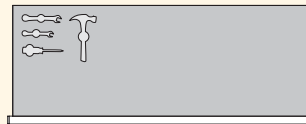

**R\_KE-J0203**  
For tools

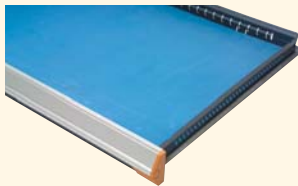

**Warning:** Cut-outs in the foam are not provided by Rousseau. They must be made by the user.

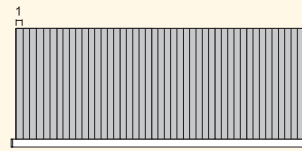

**R\_KE-G04603**  
46 groove trays

2 dividers included with each groove tray.

### Folder Hanging Bars

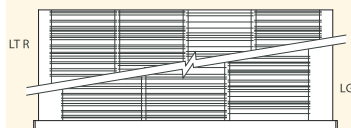

**R\_KE-KFB12**

## 60" x 27" (W x D) Drawers

For Cabinet

For Multi-Drawer

### Partitions and Dividers

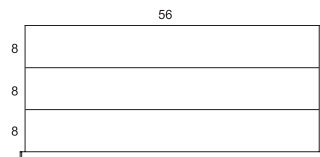

**R\_KG-B0200**  
3 compartments

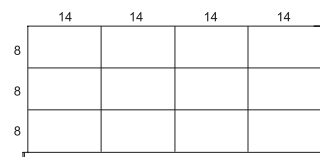

**R\_KG-A0308**  
12 compartments

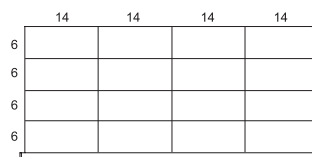

**R\_KG-A0312**  
16 compartments

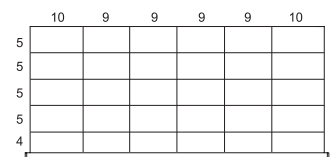

**R\_KG-A0524**  
30 compartments

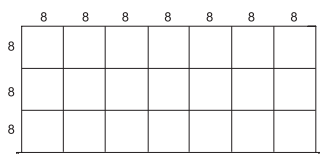

**R\_KG-A0614**  
21 compartments

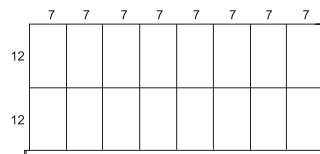

**R\_KG-A0708**  
16 compartments

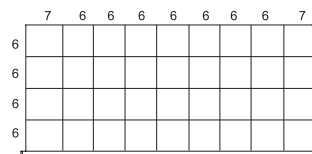

**R\_KG-A0827**  
36 compartments

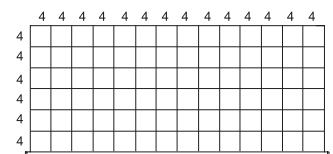

**R\_KG-A1370**  
84 compartments

## Partitions and Dividers (60" x 27" drawers continued)

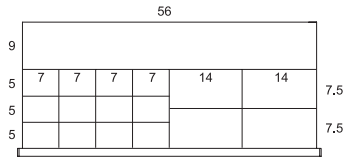

**R\_KG-C0610**  
17 compartments

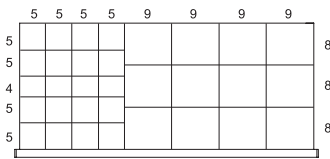

**R\_KG-D0724**  
32 compartments

## Plastic Bins

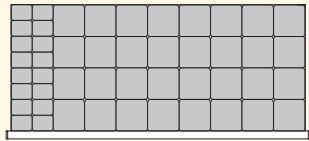

**R\_KG-E048**  
48 bins

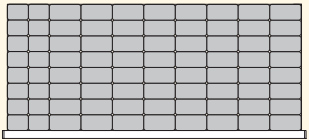

**R\_KG-E080**  
80 bins

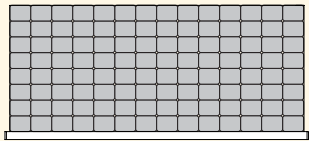

**R\_KG-E112**  
112 bins

## Foam

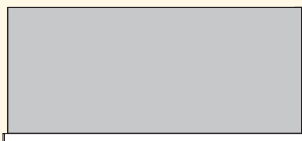

**R\_KG-J0103**  
For protection

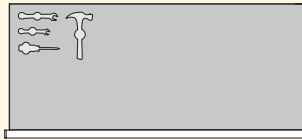

**R\_KG-J0203**  
For tools



*Cut-outs in the foam are not provided by Rousseau. They must be made by the user.*

## Groove Trays (60" x 27" drawers continued)

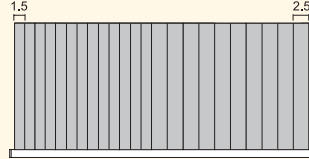

**R\_KG-G02303**  
23 groove trays

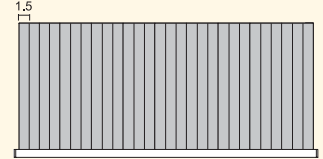

**R\_KG-G02803**  
28 groove trays

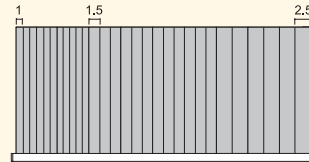

**R\_KG-G02903**  
29 groove trays

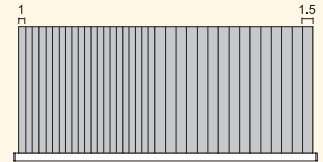

**R\_KG-G03603**  
36 groove trays

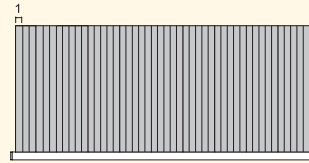

**R\_KG-G04603**  
46 groove trays

*2 dividers included with each groove tray.*

## Folder Hanging Bars

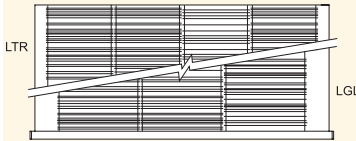

**R\_KG-KFB12**

## Examples of Available Drawer Interiors

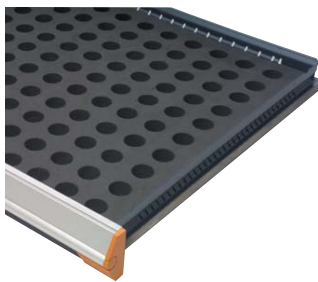

Foam for collets

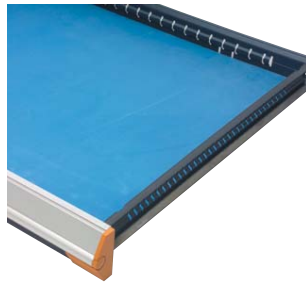

Foam for protection



Foam for tools



Groove trays



Partitions and dividers

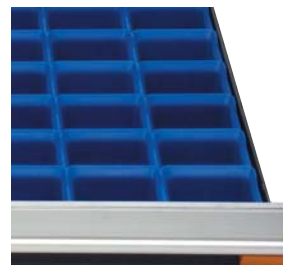

Plastic bins



Hanging file bars