



## SPECIALIZED AUTOMOTIVE STORAGE

For some years now, Rousseau has been developing a system that offers a complete and integrated storage solution for the automotive industry. Whatever your needs, we are able to provide a heavy-duty and aesthetically pleasing option for even the most discerning automotive dealer.

What we offer is more than a simple product. It is a complete system to help you organize your parts department. Included are bumper and pipe racks, sheet metal racks, battery and tire racks.

The variety and flexibility of the Rousseau line represents a great advantage. It is a system that will grow with your needs. We are proud to be able to help answer the needs of any customer, big or small, and always offer the same quality and service which has become our trademark.

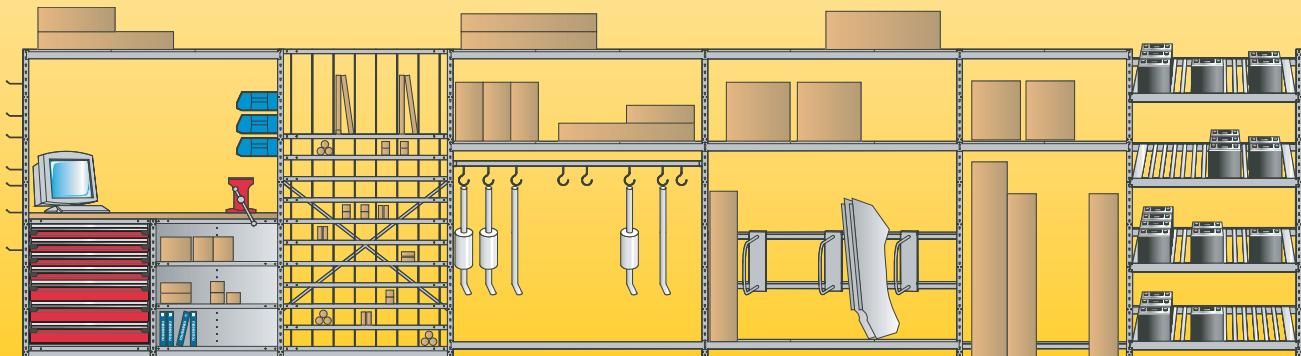

# Automotive Storage Rack

## One Solution for Each Application

The strength of our system is that it adapts to your environment and evolves with your needs.

With the numerous dimensions and variety of accessories offered, you can create your own customized layout to complement the structure of your building.

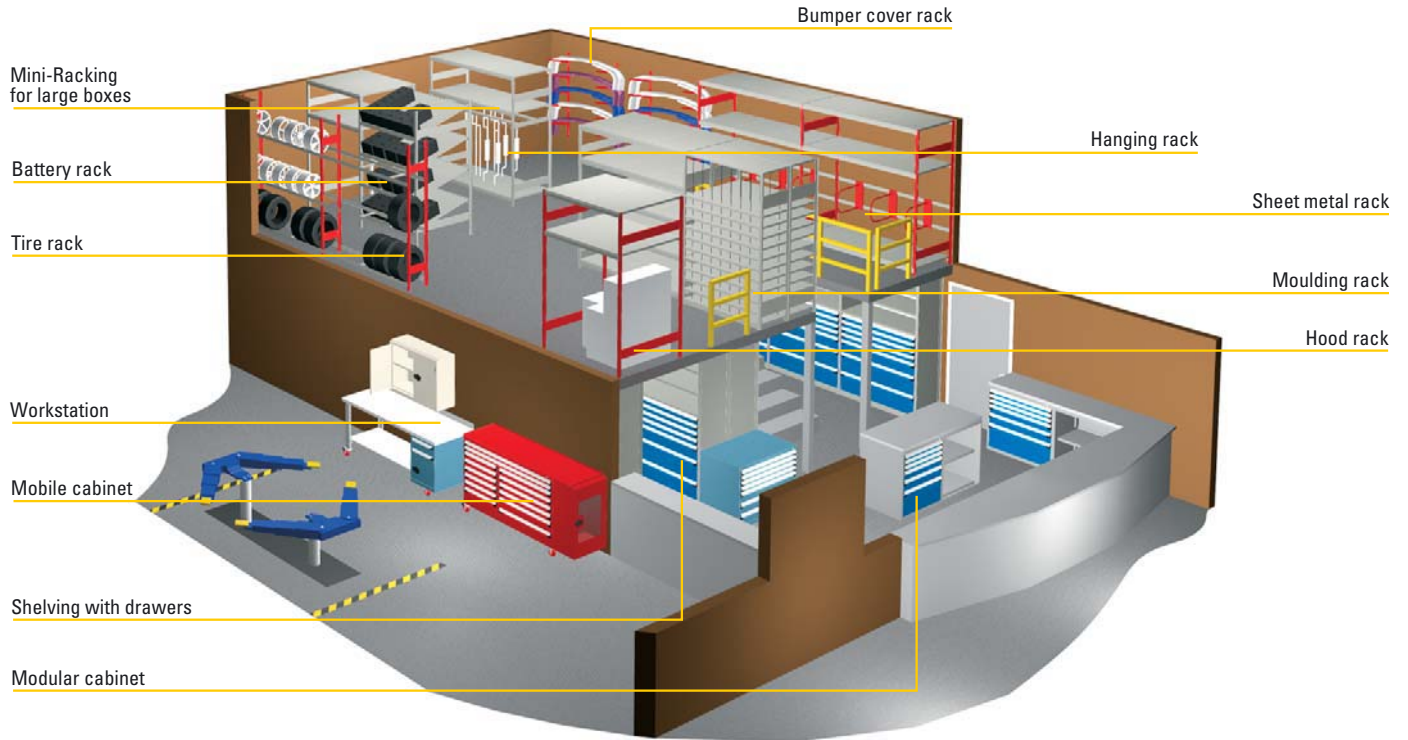

## Some Accomplishments



## Hanging Rack



SRP0404

2 welded Mini-Racking upright assemblies;  
3 steel decking levels;

The 60" and 72" W proposals include medium-duty beams and the 96" W proposals include heavy-duty beams;

To order an add-on unit, complete product number with A.

Product #	W x D x H	# of rails (hooks)
SRP1405	60" x 36" x 75"	1 (15)
SRP1406	60" x 36" x 75"	2 (30)
SRP1403	72" x 36" x 75"	1 (15)
SRP1404	72" x 36" x 75"	2 (30)
SRP1407	96" x 36" x 75"	1 (25)
SRP1408	96" x 36" x 75"	2 (45)
SRP0405	60" x 36" x 87"	1 (15)
SRP0406	60" x 36" x 87"	2 (30)
SRP0403	72" x 36" x 87"	1 (15)
<b>SRP0404</b>	72" x 36" x 87"	2 (30)
SRP0407	96" x 36" x 87"	1 (25)
SRP0408	96" x 36" x 87"	2 (45)

## Bumper and Pipe Rack



SRP0420

2 welded Mini-Racking upright assemblies;  
3 steel decking levels;

The 60" and 72" W proposals include medium-duty beams and the 96" W proposals include heavy-duty beams;

To order an add-on unit, complete product number with A.

Product #	W x D x H	# of dividers
SRP1421	60" X 36" X 75"	4
SRP2421	60" X 48" X 75"	4
SRP1420	72" X 36" X 75"	4
SRP2420	72" X 48" X 75"	4
SRP1422	96" X 36" X 75"	6
SRP2422	96" X 48" X 75"	6
SRP0421	60" X 36" X 87"	4
SRP3421	60" X 48" X 87"	4
<b>SRP0420</b>	72" X 36" X 87"	4
SRP3420	72" X 48" X 87"	4
SRP0422	96" X 36" X 87"	6
SRP3422	96" X 48" X 87"	6

## Sheet Metal Rack



SRP0430

2 welded Mini-Racking upright assemblies;  
3 steel decking levels;

The 60" and 72" W proposals include medium-duty beams and the 96" W proposals include heavy-duty beams;

To order an add-on unit, complete product number with A.

Product #	W x D x H	# of dividers
SRP1431	60" X 36" X 75"	2
SRP2431	60" X 48" X 75"	2
SRP1430	72" X 36" X 75"	2
SRP2430	72" X 48" X 75"	2
SRP1432	96" X 36" X 75"	3
SRP2432	96" X 48" X 75"	3
SRP0431	60" X 36" X 87"	2
SRP3431	60" X 48" X 87"	2
<b>SRP0430</b>	72" X 36" X 87"	2
SRP3430	72" X 48" X 87"	2
SRP0432	96" X 36" X 87"	3
SRP3432	96" X 48" X 87"	3

## Tire Rack



SRP0442

### Single Row :

2 welded Mini-Racking upright assemblies;  
3 pairs of beams for tire rack;  
2 pairs of wall spacers;  
Floor anchor plates and hardware kit.

### Double Row :

4 welded Mini-Racking upright assemblies;  
6 pairs of beams for tire rack;  
2 pairs of post spacers;  
Floor anchor plates and hardware kit;

To order an add-on unit, complete product number with A.

Product #	W x D x H	Type
SRP0443	60" X 15" X 87"	Single
SRP0444	60" X 48" X 87"	Double
SRP0441	72" X 15" X 87"	Single
<b>SRP0442</b>	72" X 48" X 87"	Double

## Battery Rack

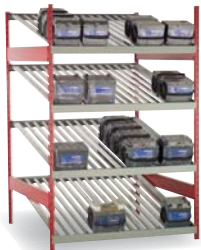

SRP0461

2 welded Mini-Racking upright assemblies;  
4 battery platforms;

87" H proposals also include one steel decking level;

To order an add-on unit, complete product number with A.

Product #	W x D x H
SRP0460	48" x 36" x 75"
<b>SRP0461</b>	48" x 48" x 75"
SRP0462	48" x 36" x 87"
SRP0463	48" x 48" x 87"

## Hood Rack



SRP0450

2 welded Mini-Racking upright assemblies;  
Medium-duty beams;

2 steel decking levels;

Floor anchor plates and hardware kit;

To order an add-on unit, complete product number with A.

Product #	W x D x H
SRP2450	48" X 48" X 75"
SRP2451	60" X 48" X 75"
<b>SRP0450</b>	48" X 48" X 87"
SRP0451	60" X 48" X 87"

**Hood Rack must be anchored to the floor (anchoring kit included).**

# Proposals

## Bumper Cover Double Rack



WMA3510

- 1-85 1/2" H centered stand;
- 12 pairs of bumper supports.

Product #	W x D x H	
WMA3510	45" x 42" x 85 1/2"	With anchoring kit
WMA3511	45" x 42" x 87"	With leveling glide kit
WMA3512	45" x 42" x 91"	With 4" casters : 2 rigid and 2 swivel with total-lock brake
WMA3513	45" x 42" x 91"	With 4" casters : 2 swivel and 2 swivel with total-lock brake

## Wall-Mounted Bumper Cover Rack



- 6 pairs of bumper supports;
- 2 multi-purpose wall-mounted uprights, 300 lb capacity (wall and wall anchoring must be strong enough);
- Wall anchoring not included.

Product #	W x D x H
WMP1000	42" X 23" X 72"

## Moulding Rack



SRP0410

- 4 upright assemblies;
- 1 back sway brace;
- Dividing rods;
- To order an add-on unit, complete product number with A.

Product #	W x D x H	# of Shelves	# of Spaces
SRP0413	36" x 48" x 75"	10	54
SRP0411	36" x 48" x 87"	12	66
SRP0412	48" x 48" x 75"	10	72
SRP0410	48" x 48" x 87"	12	88



## Components

### Double Divider for Mini-Racking

SR60

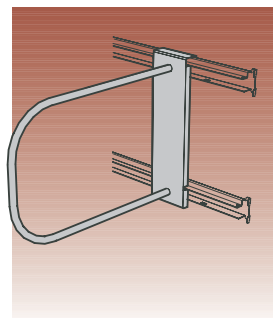

- Supports parts and boxes that are stored vertically in a Mini-Racking unit. Parts lean against the "D" shape of the divider;
- Attaches on 2 SR21 medium-duty beams or 2 SR22 heavy-duty beams;
- Space between the two beams should be 14" c/c;
- Divider can be adjusted laterally (left to right) without tools;
- Locks in position when load is applied laterally;
- Compatible with shelving 24" deep and deeper.

Product #	W x D
SR60-2415	24" x 15"

### Single Divider for Mini-Racking

SR61

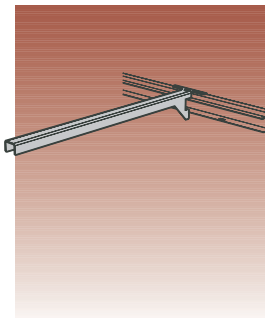

- Divides those parts that lean vertically against the back of the Mini-Racking;
- Installs on SR21 medium-duty beams or SR22 heavy-duty beams ;
- Dividers can be adjusted laterally (left to right) without tools;
- Locks in position when load is applied laterally;
- Compatible with shelving 24" deep and deeper.

Product #	Depth
SR61-2401	24"

AUTOMOTIVE

## Hanging Rail – Single and Double

SR62

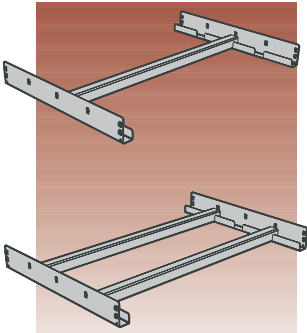

Single rail: SR62-XXXX01;  
 Double rail: SR62-XXXX02;  
 For storage of parts of non-standard sizes;  
 300 lb capacity per rail;  
 Rail adaptors :  
 Install on the Spider® post with hooks, no bolts;  
 Includes security mechanism to keep from accidentally unhooking;  
 3 installation positions possible : one in the middle and two closer to the edges;  
 Compatible with SR63-02 hooks (not included);  
 Hooks pivot once installed on the rail. They can be put on and taken off the rail at all times, even when the rail is in place on the adaptors;  
 Rail and adaptors in galvanized steel;  
 When ordering, specify the last 2 digits in the number code. Ex. : SR62-602402

Product #	W x D
SR62-601801	60" x 18"
SR62-6024	60" x 24"
SR62-6036	60" x 36"
SR62-721801	72" x 18"
SR62-7224	72" x 24"
SR62-7236	72" x 36"
SR62-961801	96" x 18"
SR62-9624	96" x 24"
SR62-9636	96" x 36"

**NOTE** To order a unit of industrial shelving or Mini-Racking,

SEE PAGES 48-69

## Hook for Hanging Rail

SR63

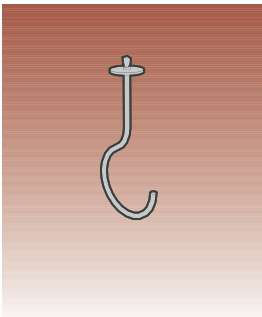

50 lb capacity per hook;  
 Hooks pivot once installed on the SR62 rail;  
 They can be put on and taken off even when the rail is in place on the adaptors.

Product #	Height
SR63-02	5"

## Dividing Rods

SH56

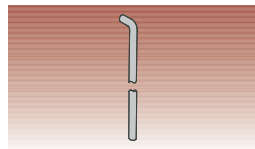

Sold in pairs;  
 Steel rods with 1/4" diameter;  
 90° fold at one end to ensure it stays in place;  
 Superior rigidity compared to plastic rods currently used on the market for this type of application.

Product #	Height
SH56-72	72"
SH56-84	84"
SH56-96	96"

## Wall Spacers

SR45

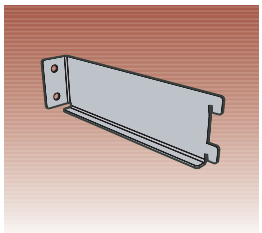

Sold in pairs;  
 Spaces shelving 9" away from the wall;  
 Attaches to the SR post in the delta holes without tools; must be secured in place with plastic clip (included);  
 Galvanized steel.

Product #	Depth
SR45-09	9"

## Post Spacers

SR48

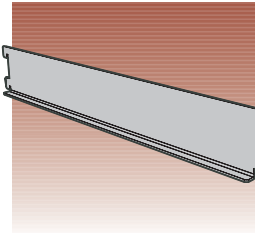

Sold in pairs;  
 Spaces two back-to-back shelving units 18" apart;  
 Attaches to the SR post in the delta holes without tools; must be secured in place with plastic clips (included);  
 Galvanized steel.

Product #	Depth
SR48-18	18"

## Beams for Tire Rack

SR20

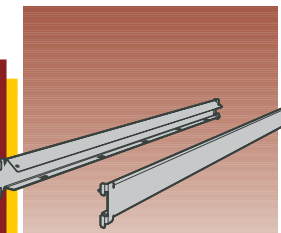

Sold in pairs;  
 340 lb capacity per pair;  
 Allows for storage of popular sized tires of different dimensions up to 17" in diameter (light truck and SUV);  
 Constructed with a sloped surface to prevent the deformation of tires;  
 72" wide beams require a tie bar installed in the center;  
 15" deep units recommended for tires;  
 12" deep units recommended for rims.

Product #	Width
SR20-36	36"
SR20-48	48"
SR20-60	60"
SR20-72	72"

## Battery Platform

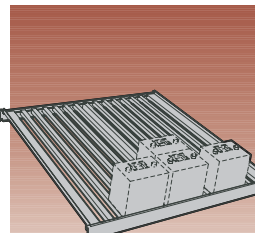

Level includes 2 heavy-duty beams and 13 tie bars;  
 Equipped with a front stop and two side rails to prevent the batteries from falling;  
 15° inclination eases the movement of batteries forward for easy access;  
 Galvanized steel.

Product #	W x D	# of batteries (medium size)
SRP9001	48" x 36"	20
SRP9002	48" x 48"	28

**NOTE** To order a unit of industrial shelving or Mini-racking,

SEE PAGES 48-69